

# CB 230 RTS

Installation instructions - Illustrations

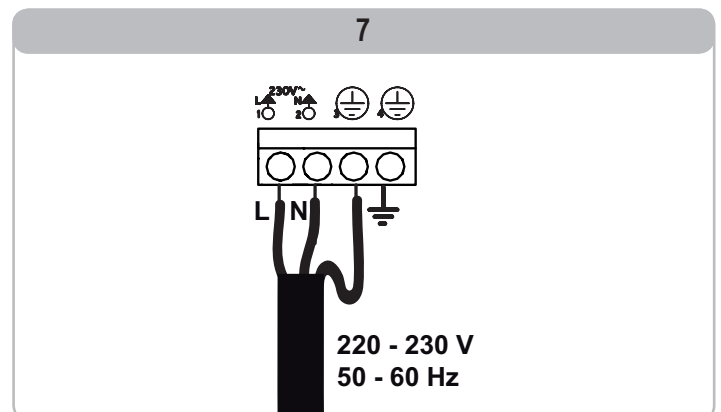

8

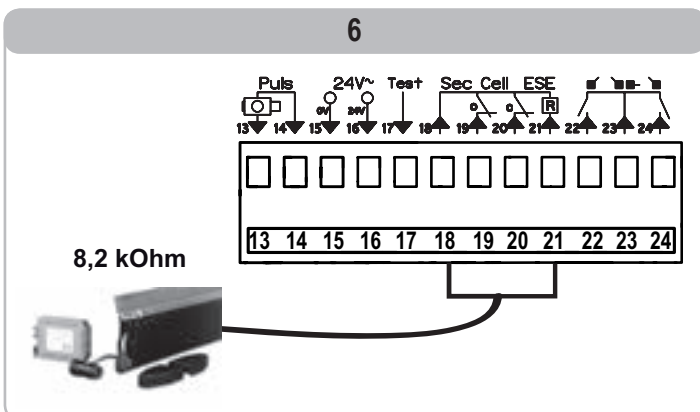
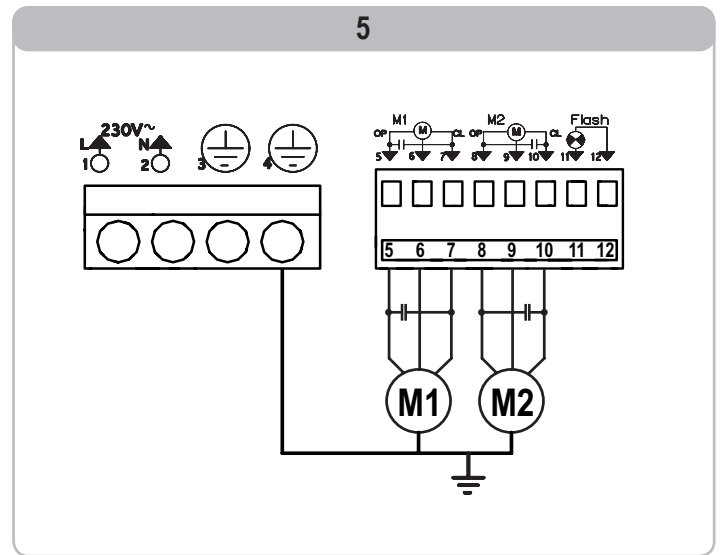
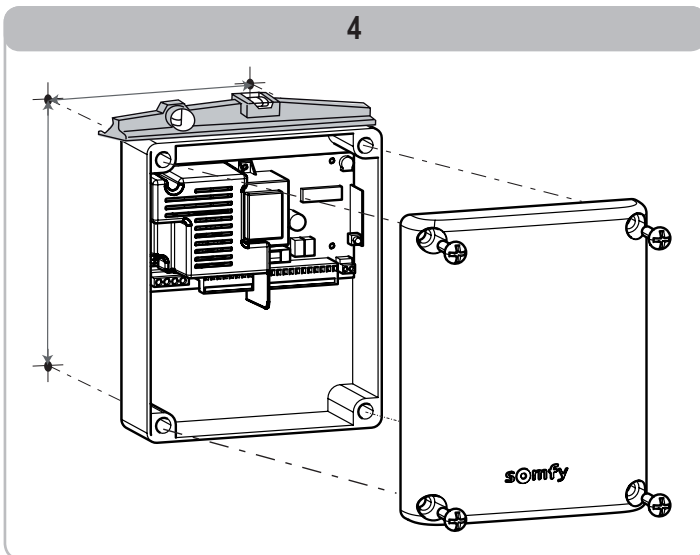
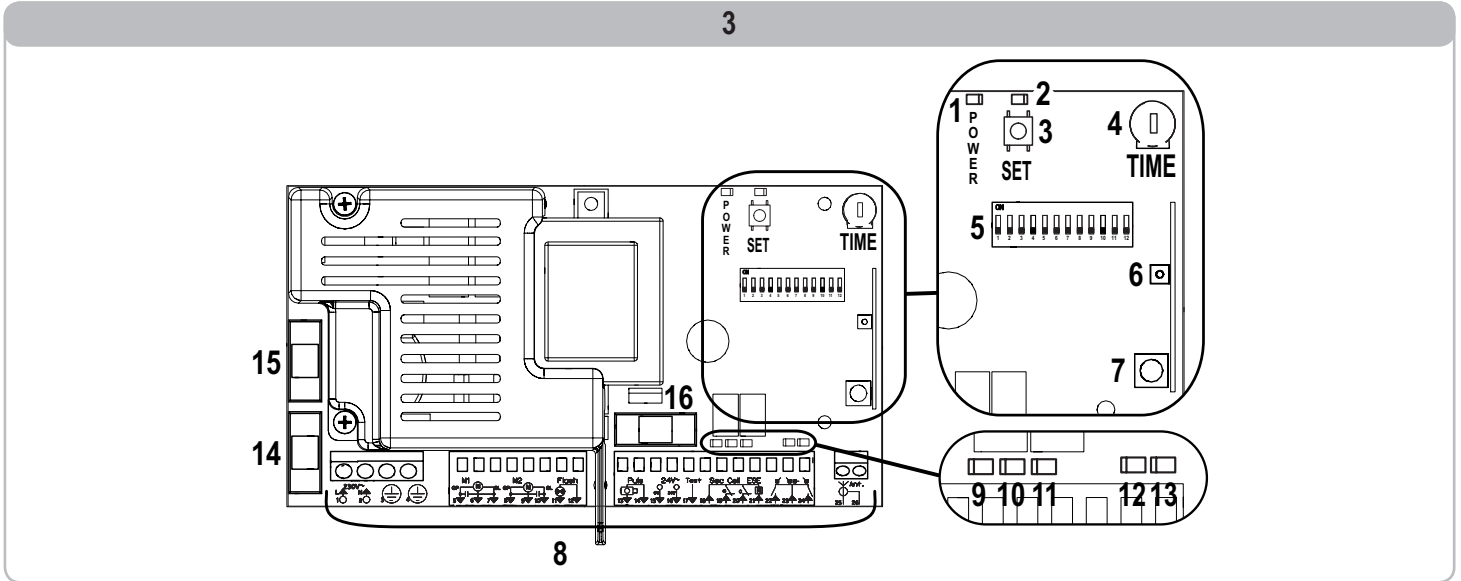
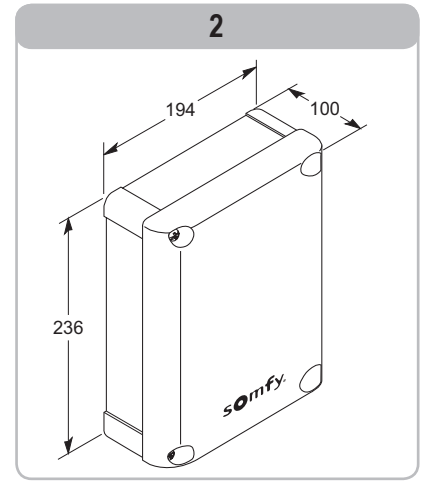
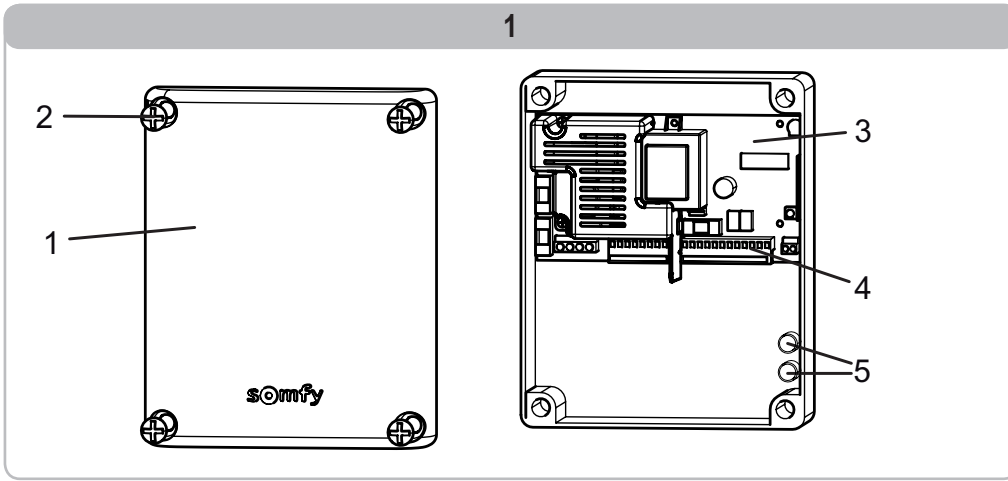
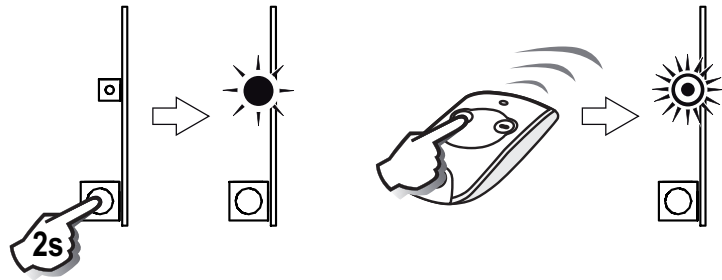
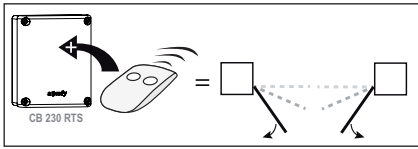

9

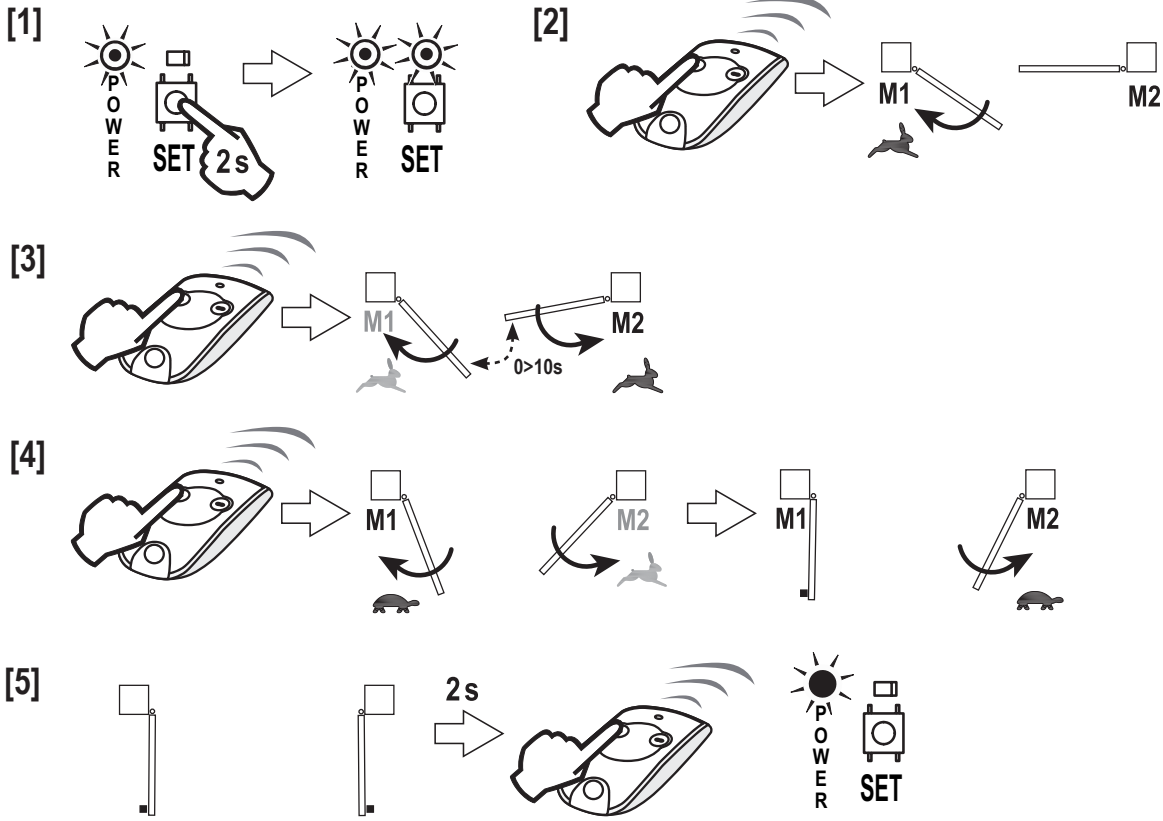

10

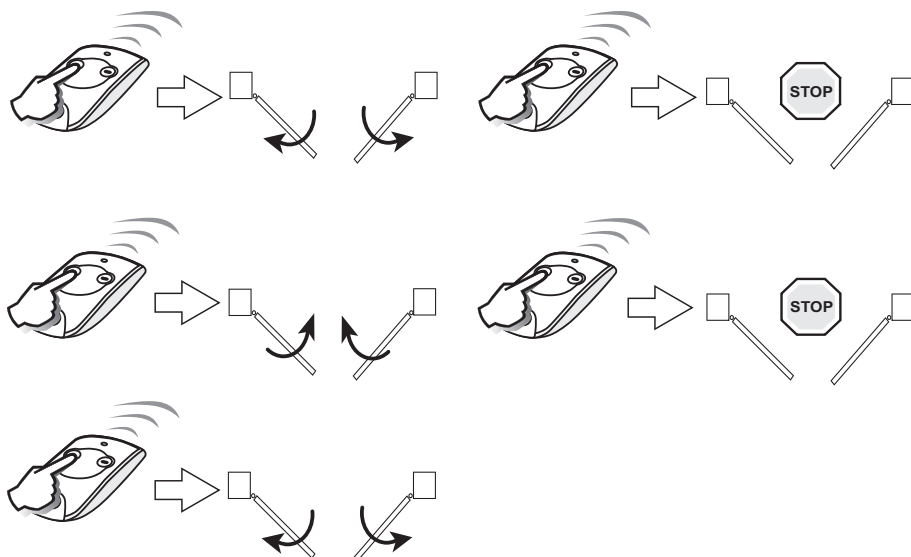

11

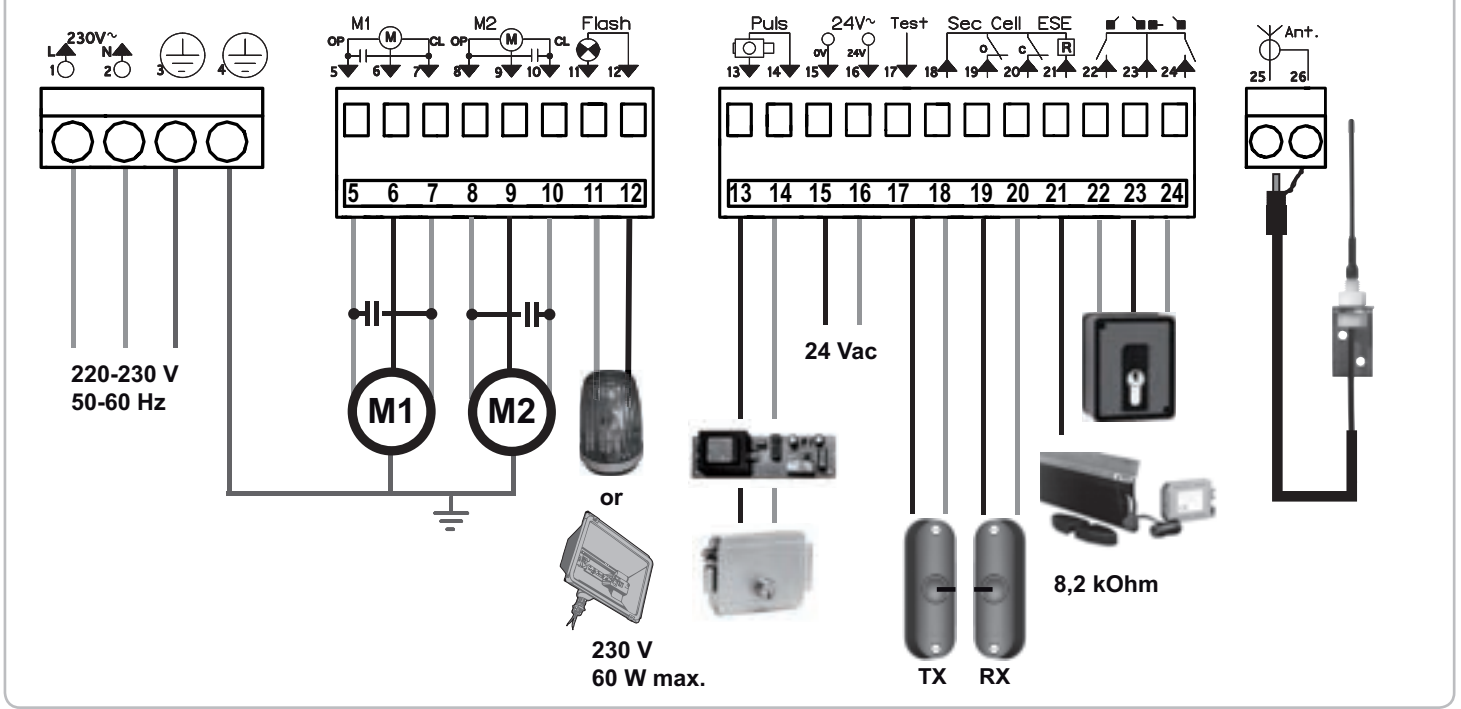

12

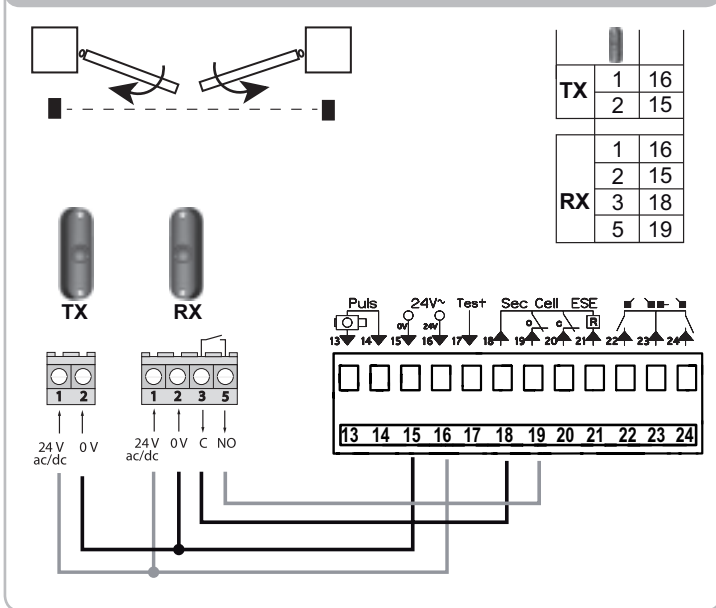

13

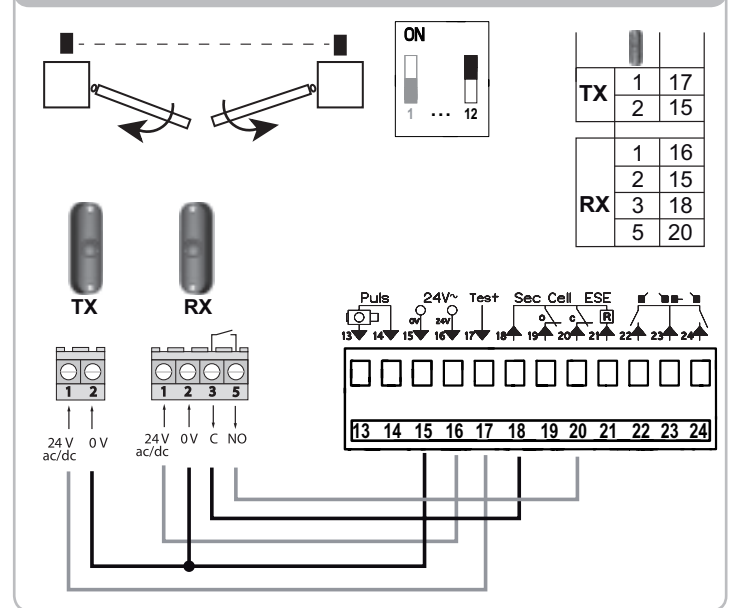

14

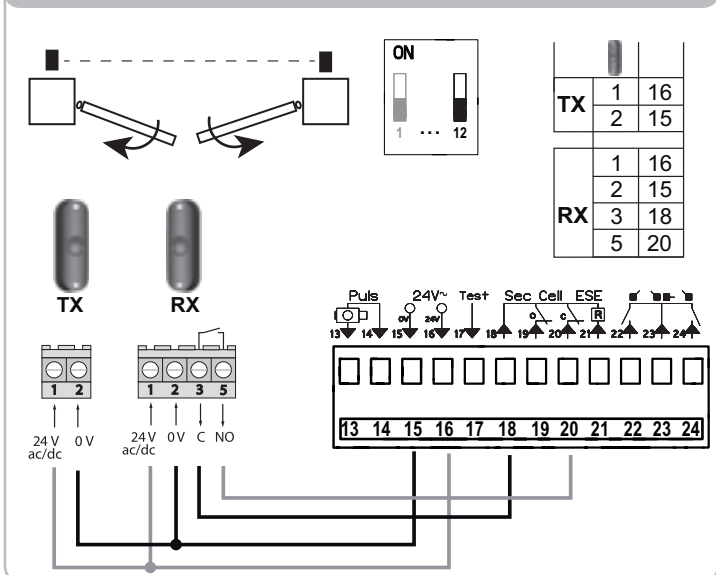

15

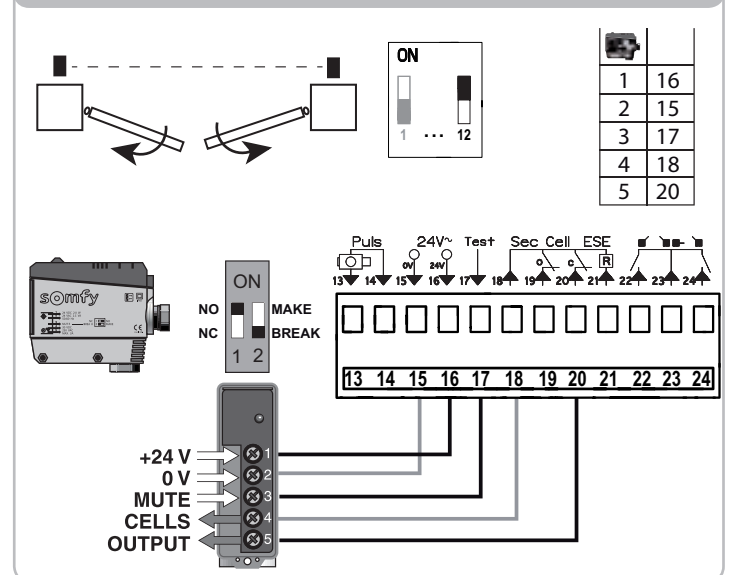

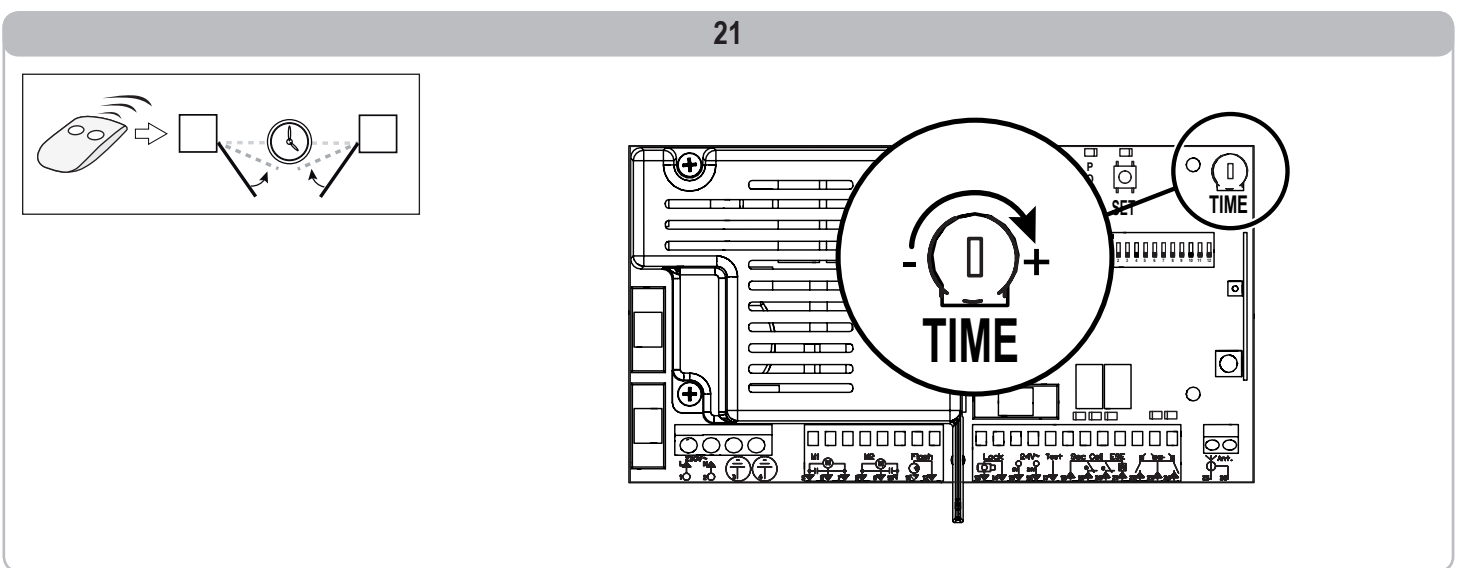
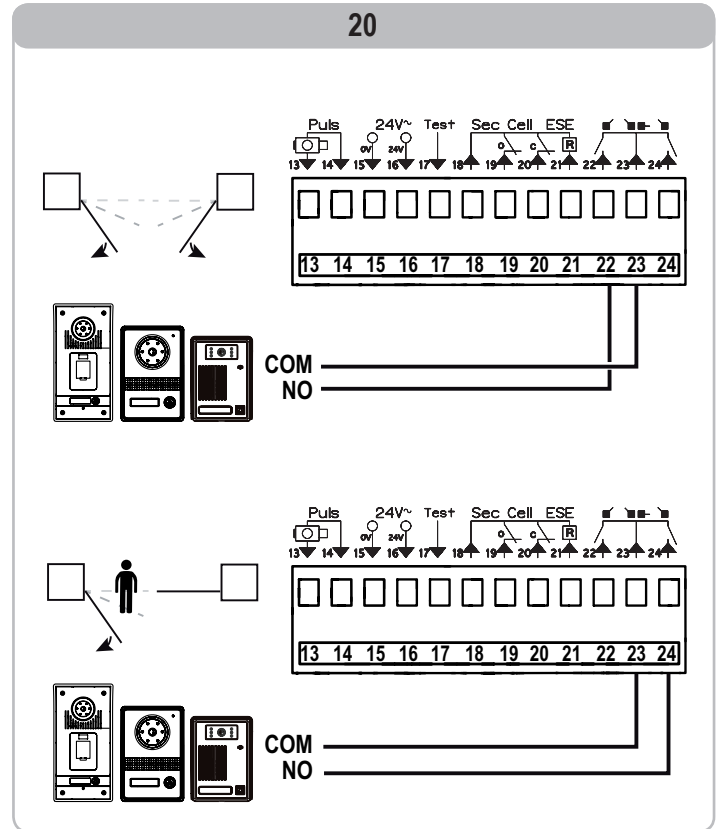
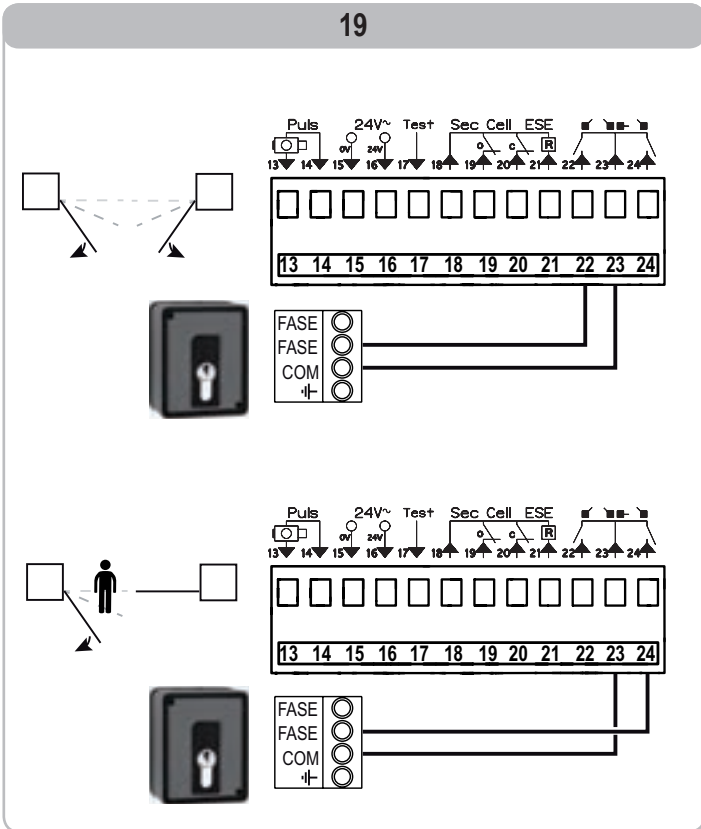
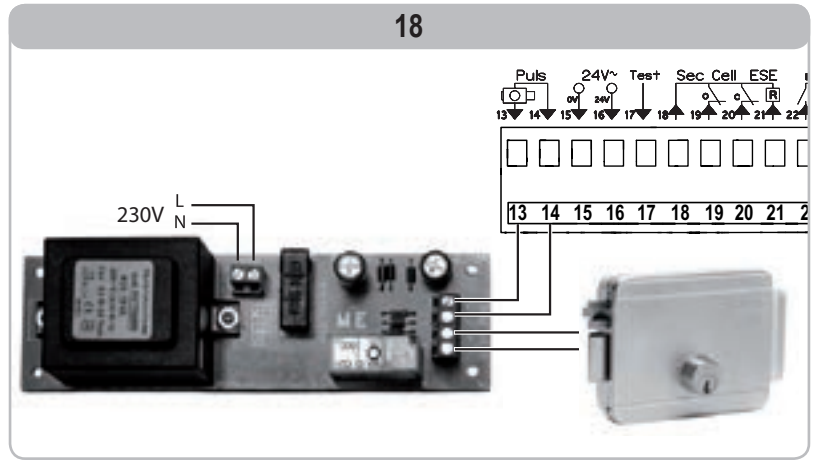
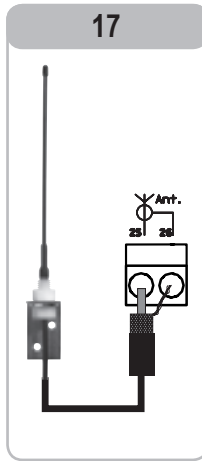
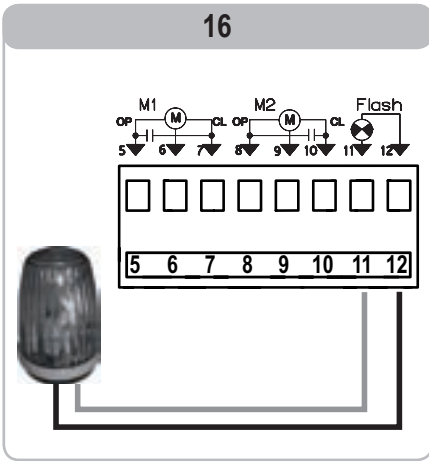

22

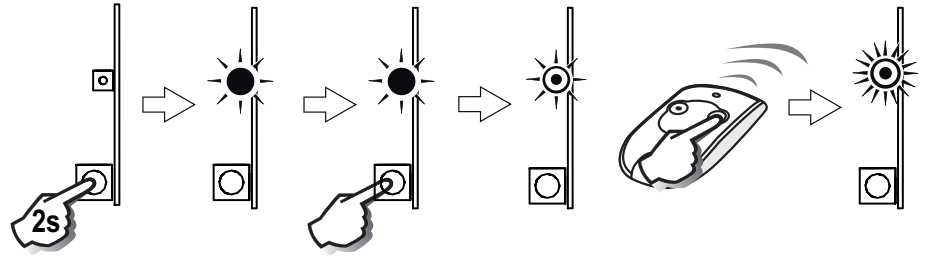
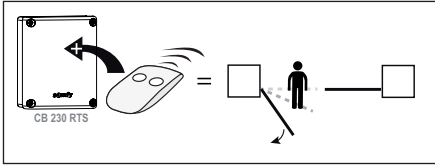

23

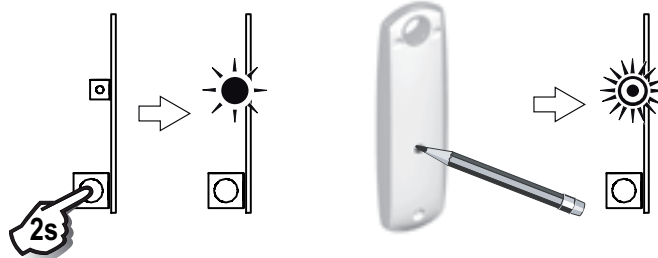
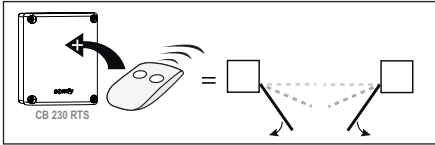

24

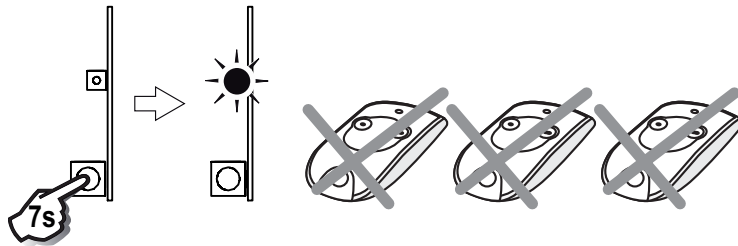

25

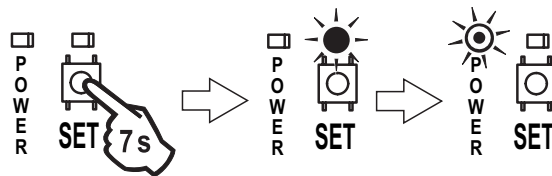



**Somfy**

50 avenue du Nouveau Monde  
BP 152 - 74307 Cluses Cedex  
France

[www.somfy.com](http://www.somfy.com)

5121605A

HOME MOTION by  
**somfy**

